

EN

Welcome! to our world

RM[®]
GROUP

**EXTREMELY POWERFUL
INCREDIBLY MOBILE**

RM SCREENS

RUBBLEMASTER.COM



RM GROUP FACTS

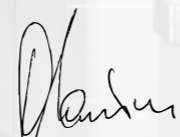

"It all started with a vision: we wanted to make it possible to recycle C&D waste materials on site. This innovative idea became an international success, and we are now the world leader in compact crushing and screening. This folder provides you with an overview of our crushers and screens, which make it possible to process C&D waste materials and natural rock on site profitably. Please contact us - we look forward to talking to you!"

Gerald Hanisch
Founder and Managing Director
RUBBLE MASTER HMH GmbH

WELCOME! TO OUR WORLD

From pioneer of on-site recycling to world leader of compact crushing and screening! We can rely on our proven assets as we move from strength to strength. With highly innovative products, strong service and customer orientation and the best team in the industry, we are always one step ahead.

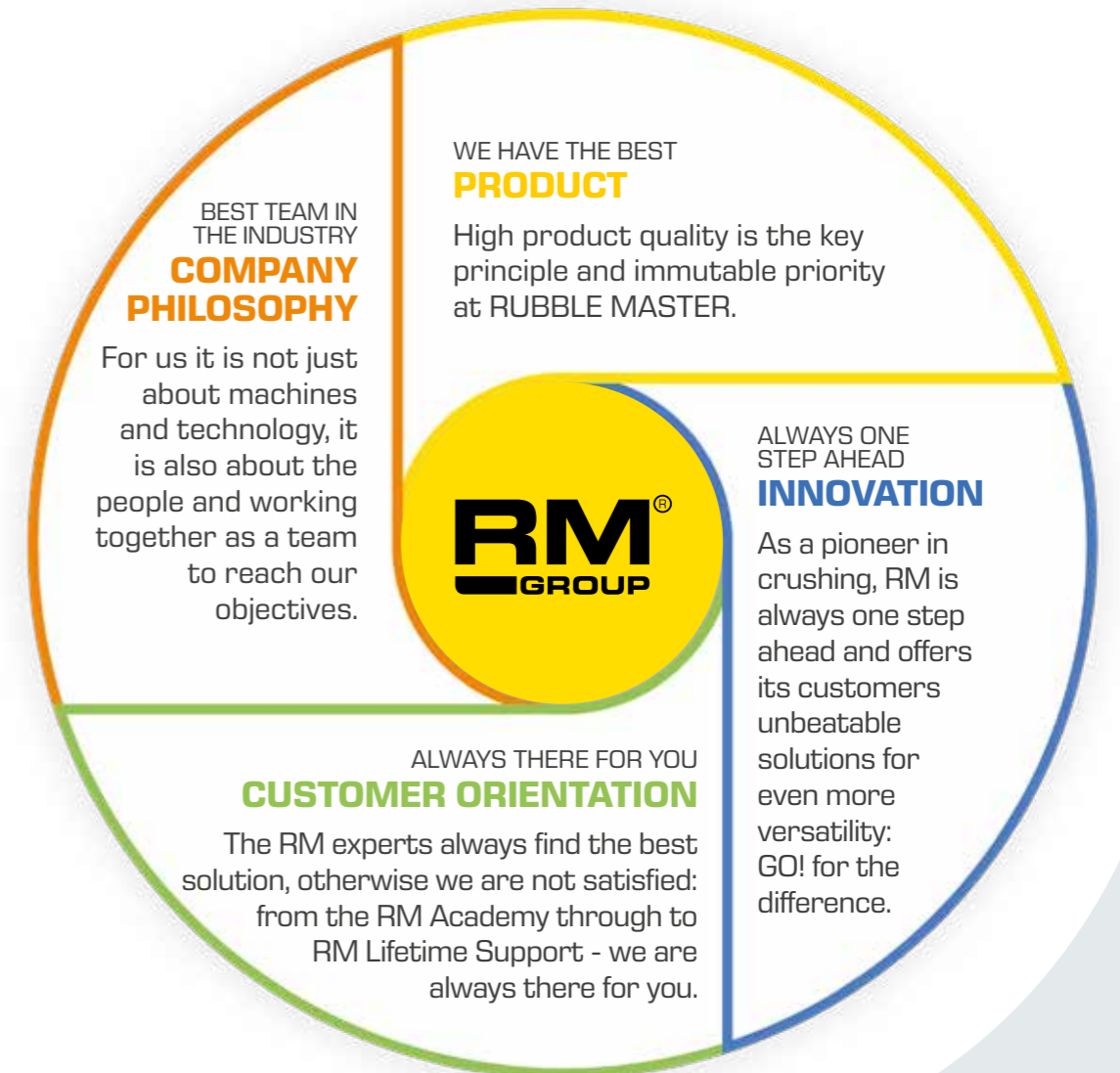

HIGHLIGHTS RM HS SERIES

SCALPERS – Coarse material screening equipment

The screens in the SCALPER series are durable, robust, high performance machines designed to handle the heaviest applications in the harshest conditions. Whether it's heavy rock or bulky construction and demolition material, thanks to their versatility and high throughput the SCALPER series screens minimise material handling and deliver high quality end products.



Feed hopper

Large feed hopper with a heavy duty multiply belt as standard. The speed of the belt feeder is adjustable to ensure smooth material flow onto the screenbox.

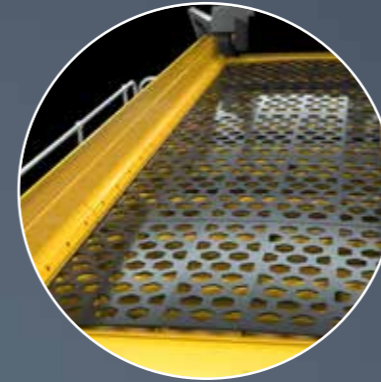

Screen decks

Multitude of combinations and configurations for top and bottom decks including e.g. punch plate, before screen, finger deck, square and elongated meshes – one scalper for different applications.



Medium and fine material belts

Adjustable speed, as well as over the top folding for optimized transport dimensions.



Wide access engine compartment doors

Provide perfect access for service and maintenance of engine and hydraulics.



High power screenbox

Features adjustable screenbox angle (except RM HS3500M) with an amplitude of up to 10 mm achieves highly accurate material split with exceptional throughput performance even when screening the most difficult materials.



Hardox apron

Optional – robust construction allowing for use in difficult and heavy duty materials.

“THE FULL PACKAGE”

RM delivers a top quality package: straightforward set-up, flexibility, high material quality, profitability, simple maintenance, intuitive operation and great design: ideal for on-site action.

Billy Todd, USA, Owner of 108 Excavating

Not every option is available for all machines.

RM HS SERIES

SCALPER SERIES –
COARSE MATERIAL SCREENING EQUIPMENT

	RM HS3500M	RM HS5000M	RM HS7500M	RM HS11000M
Screenbox				
screen surface	2,743 x 1,220 mm	3,660 x 1,420 mm	4,880 x 1,525 mm	6,100 x 1,830 mm
angle	14°	15° - 20°	15° - 20°	13° - 17°
Feed hopper				
volume	5 m ³	6 m ³	8.7 m ³	8.7 m ³
belt width	1,050 mm	1,300 mm	1,400 mm	1,400 mm
Oversize material discharge belt				
belt width	1,050 mm	1,200 mm	1,600 mm	1,600 mm
discharge height	3,430 mm	2,580 - 3,735 mm	2,980 - 3,750 mm	2,700 - 3,900 mm
Midsized discharge belt				
belt width	650 mm	800 mm	900 mm	1,000 mm
discharge height	3,145 mm	3,670 mm	3,780 mm	3,100 mm
Fines discharge belt				
belt width	650 mm	800 mm	900 mm	1,050 mm
discharge height	3,145 mm	3,870 mm	4,080 mm	3,700 mm
Transport dimensions (L x W x H)	9,880 x 2,550 x 3,190 mm	13,440 x 2,730 x 3,200 mm	15,005 x 2,920 x 3,430 mm	16,345 x 3,000 x 3,550 mm
Weight basic machine	16,500 kg	24,500 kg	33,000 kg	43,000 kg



JOB STORY

RM HS5000M TURNS EXCAVATED LIMESTONE INTO VALUE AGGREGATE

Excavated material from a large construction site in Hallein is crushed and screened using RM machines and then resold

Material excavated from an underground car park construction site is first crushed by the RM 120GO!. The limestone is then screened by the RM HS5000M into 0/8, 8/16 and 16/32 fractions. The 8/16 material is sold immediately as filter gravel for a nearby highway renovation project.

WORKING DIMENSIONS

RM HS3500M

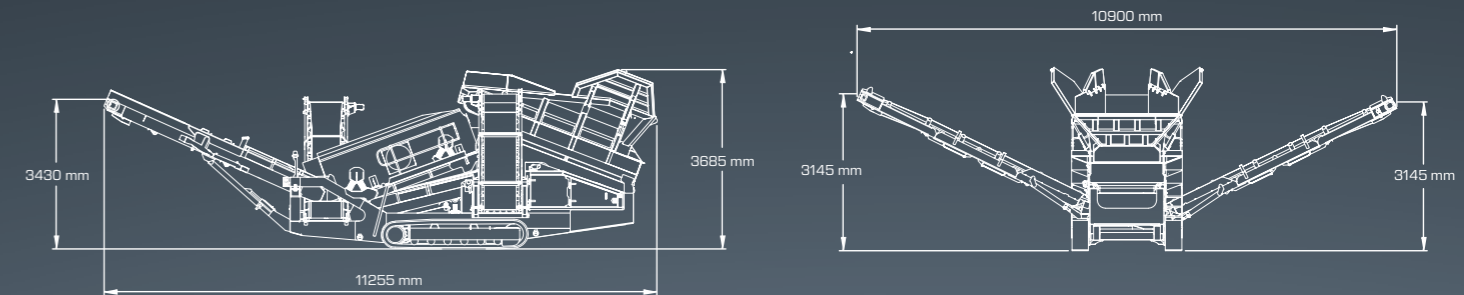

RM HS5000M

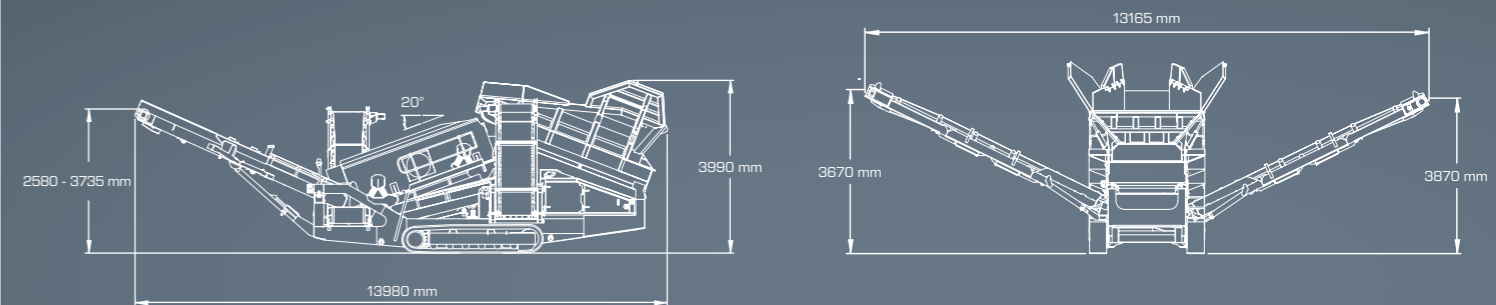

RM HS7500M

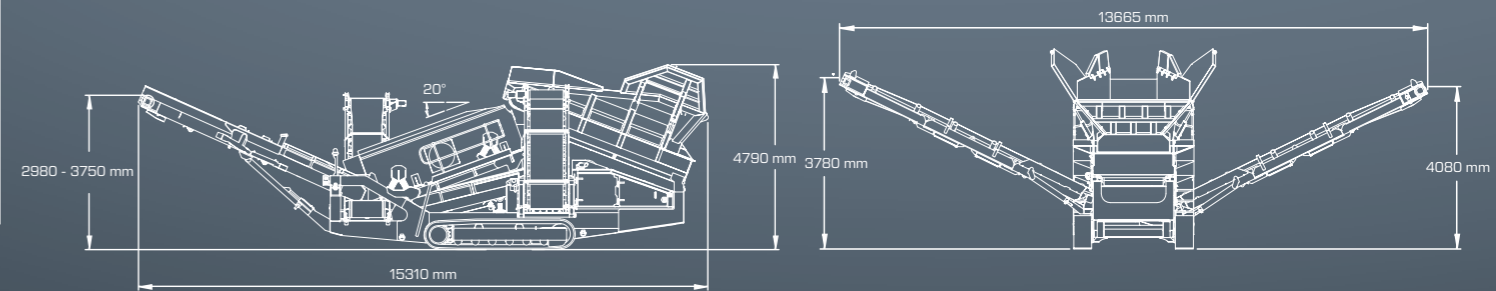

RM HS11000M

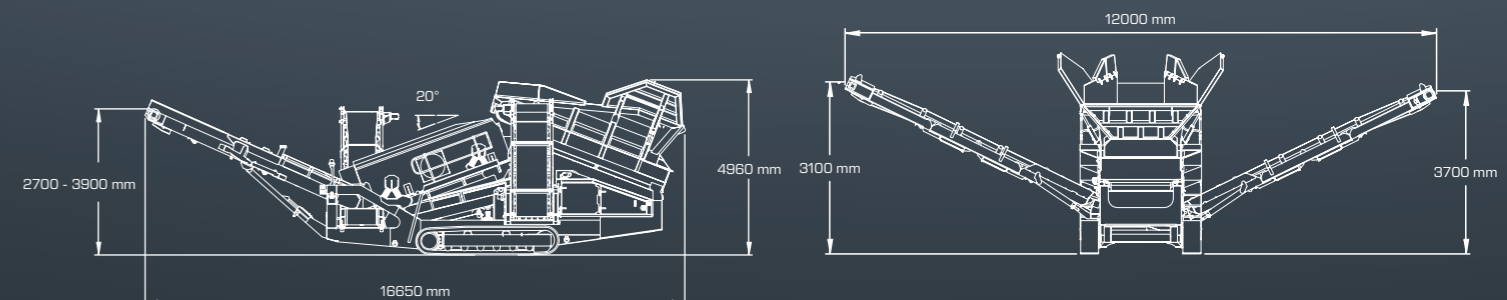

Dimensions in m. Specifications subject to change in line with technical developments. Machines comply with Guideline 2006/42/EC of the European Parliament.

HIGHLIGHTS RM MSC SERIES

RM SIZING SCREENS – vibrating post screening equipment

RUBBLE MASTER sizing screens have been developed for operators who require high volumes of high grade aggregate material. The unique high power screenbox design is the optimum in screenbox dynamics. With the addition of the 4th product conveyor it can produce up to 4 different grades of materials.



Wedge clamping system
Rapid and user-friendly screen change.



9.2 m³ hopper, wide loading area
Enables the use of wider loading buckets.



Wide access engine compartment doors
Provide perfect access for service and maintenance of engine and hydraulics.



Wide chutes and discharge belts
Ensures optimum material flow and longer belt life with adjustable belt speeds.

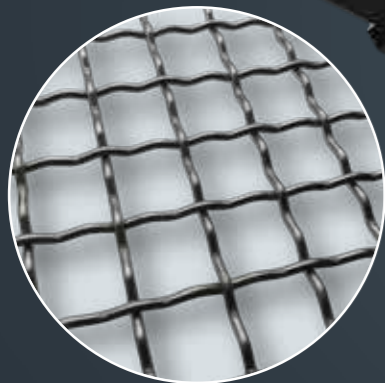

Screen decks
Multitude of combinations and configurations for top and bottom deck including e.g. square and elongated meshes and harp screens.



Optional hopper door
Controlled adjustable material flow from hopper to main conveyor.



Rinser option
Wet screening for increased product quality.

“UNIQUE MATERIAL QUALITY”

RUBBLE MASTER has changed my business. I am proud of the high quality end product. Large competitors cannot match my material quality.

Alfred Lauzon, Kanada, CEO, Northern Paving

Not every option is available for all machines.

RM MSC SERIES

SIZING SERIES
VIBRATING SCREENING EQUIPMENT

	RM MSC5700M-2D	RM MSC8500M-2D	RM MSC8500M-3D	RM MSC10500M-2D	RM MSC10500M-3D
Screenbox					
screen surface	3,660 x 1,525 mm	5,485 x 1,525 mm	5,485 x 1,525 mm	6,700 x 1,525 mm	6,700 x 1,525 mm
angle	25° - 35°	18° - 30°	20° - 30°	20° - 30°	20° - 30°
Feed hopper					
volume	9,2 m ³	9,2 m ³	9,2 m ³	9,2 m ³	9,2 m ³
belt width	1,050 mm	1,050 mm	1,050 mm	1,050 mm	1,050 mm
Main conveyor					
belt width	1,050 mm	1,050 mm	1,050 mm	1,050 mm	1,050 mm
Fines discharge belt					
belt width	1,200 mm	1,200 mm	1,200 mm	1,200 mm	1,200 mm
discharge height	3,300 - 4,555 mm	3,750 - 4,960 mm	3,880 - 5,025 mm	4,300 - 5,675 mm	4,700 - 5,725 mm
Side discharge belt					
belt width	650 mm	800 mm	800 mm	800 mm	800 mm
discharge height	5,050 mm	5,100 mm	4,700 mm 4,615 mm	5,100 mm	5,100 mm
Transport dimensions (L x W x H)	15,850 x 3,000 x 3,330 mm	17,650 x 3,000 x 3,400 mm	17,610 x 3,000 x 3,550 mm	18,850 x 3,000 x 3,400 mm	18,860 x 3,000 x 3,500 mm
Weight					
basic machine	26,800 kg	32,000 kg	34,500 kg	33,000 kg	35,500 kg
Rinser option					
including spray bars and catchbox	—	optional	optional	optional	optional



JOB STORY

PROCESSING GRANITE WITH RM CRUSHER & SCREEN COMBINATION

In use 12 hours per day with various materials

Impressive all round thanks to high throughput of reinforced concrete and granite, rapid set-up and reliable customer service. Even with extremely abrasive granite with a silicate content of up to 80 %, the RM combination outputs up to 120 t/h. The RM MSC5700M post screen separates the value aggregate into the specified fractions 0-6 and 6-22 mm.

Dimensions in mm. Specifications subject to change in line with technical developments. The machine complies with Guideline 2006/42/EC of the European Parliament.

WORKING DIMENSIONS

RM MSC5700M-2D

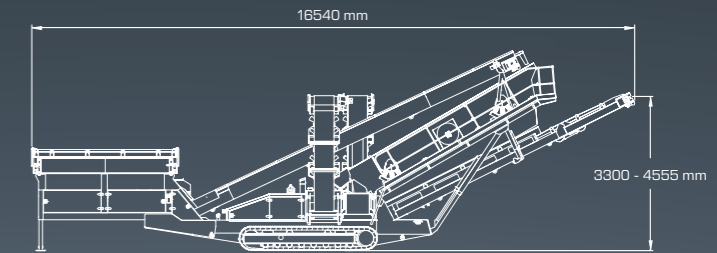
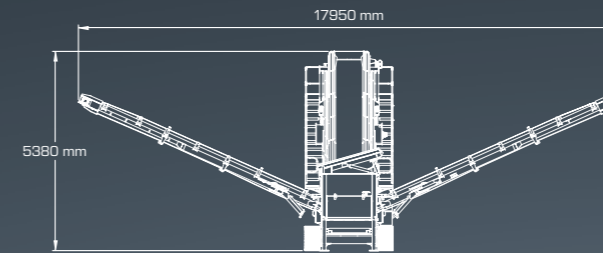

RM MSC8500M-2D

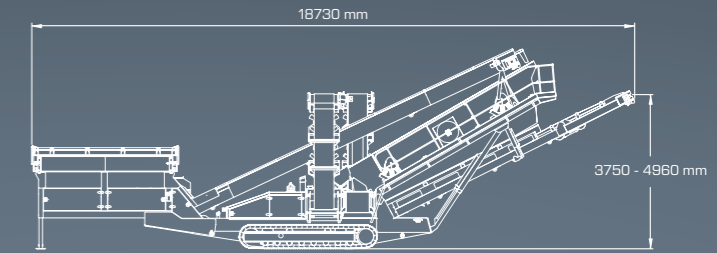
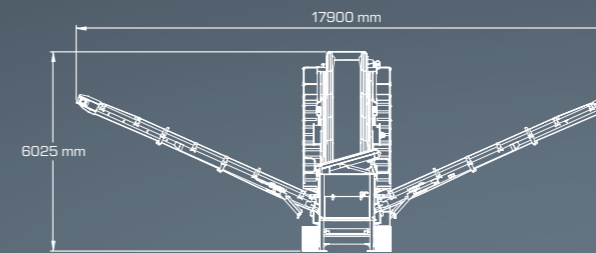

RM MSC8500M-3D

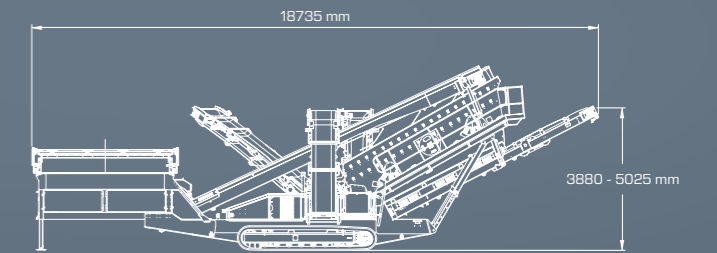
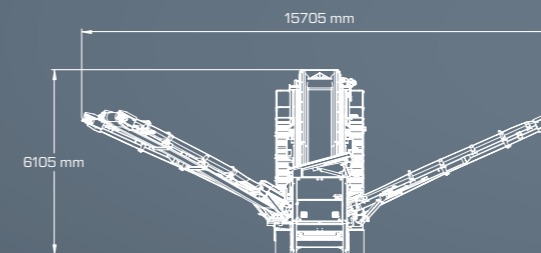

RM MSC10500-2D

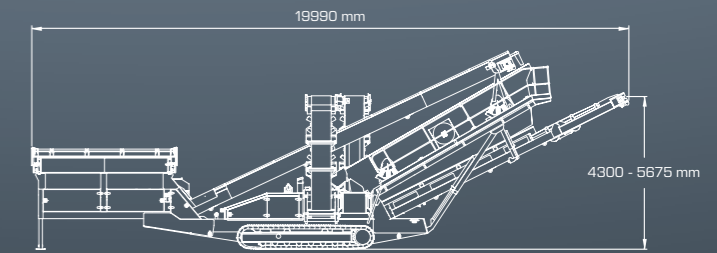
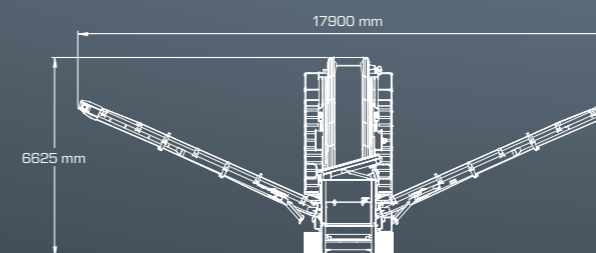

RM MSC10500-3D

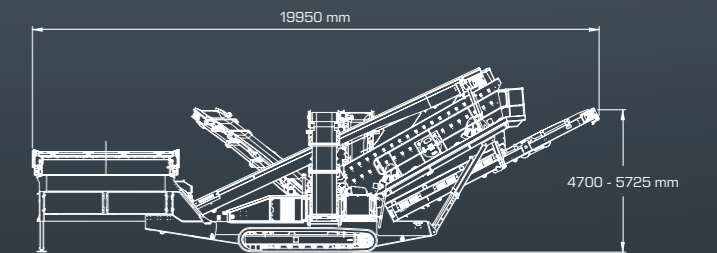
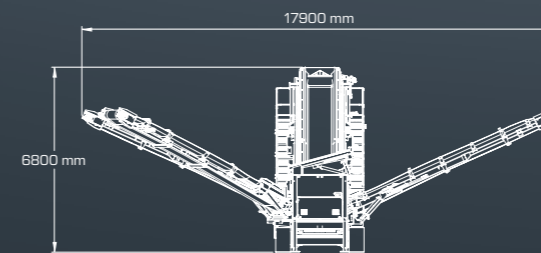

HIGHLIGHTS RM CS SERIES

CONTAINER SCREEN – Skid-mounted screening equipment

A post screen for every crusher. Each size of screen in the CS series is designed to be perfectly compatible with our mobile crushers. All the screens are powerful and process grain from recycling and natural rock as well as round grain to standardised grain sizes.

Depending on the type of screen and crusher, between one and three fractions can be produced in a single pass. Like all RM products, the post screens in the CS series stand out thanks to their low maintenance requirement and useful features, such as self-cleaning screen decks.



Large screen media range
RM offers a wide selection of different screen decks to optimise the screening process and achieve the right grade aggregate.



Compact design
Compact, lightweight and mobile: the CS series are quickly transported to any job site using a hook-lift truck.



Small footprint
Enables truly compact set-up areas.



Plugs in to crusher
Enormous energy savings due to screener being powered by crusher.



Advanced technology
Excellent screening accuracy even at maximum throughput; highly efficient thanks to self-cleaning screen deck options.



Suits your needs
Versatile and very efficient for sorting recycling, building materials and natural rock.



Fast set up times
CS series screens are quickly transported and ready for action within minutes.



Portable quarry
True versatility to produce high quality aggregates.

“COMPACT AND RELIABLE”

RM stands for reliable and compact systems featuring innovative technology and high quality materials.

Mauricio Andrade Sanchez, Mexiko, CEO and Owner, Euro Representaciones S.A. de C.V.

RM CS SERIES

RM CS SERIES HOOK LIFT MOBILE SCREENS

	RM CS2500 1D/2D	RM CS3600 2D	RM CS4800 2D
Screen mesh size	2,500 x 1,000 mm	3,000 x 1,200 mm	3,500 x 1,300 mm
Deck data	1 deck (2 deck)	2 deck	2 deck
Screenbox, angle	8° - 15°	8° - 15°	7,5° - 13,5°
Output	up to 80 t/h (100 t/h), depending on screen angle, mesh size and feed material	up to 150 t/h, depending on screen angle, mesh size and feed material	up to 250 t/h, depending on screen angle, mesh size and feed material
Drive	Crusher plug in or external	Crusher plug in or external	Crusher plug in or external
Feed material size	Edge length max. 70 mm	Edge length max. 70 mm	Edge length max. 70 mm
Screening range	0/4 to 0/40 mm	0/4 to 0/40 mm	0/4 to 0/40 mm
Fines discharge belt			
conveyor length	9,600 mm	8,760 mm	9,155 mm
discharge height	2,600 - 3,700 mm	2,400 - 3,440 mm	2,340 - 3,265 mm
Midsized discharge belt			
conveyor length	6,700 mm	6,835 mm	7,500 mm
discharge height	2,300 - 3,300 mm	2,510 - 3,850 mm	2,680 - 3,970 mm
Oversize discharge belt			
conveyor length	6,700 mm	6,835 mm	7,500 mm
discharge height	2,300 - 3,300 mm	2,510 - 3,850 mm	2,680 - 3,970 mm
Transport dimensions (L x W x H)	7,530 x 2,200 x 2,840 mm	7,640 x 2,480 x 2,270 mm	8,220 x 2,400 x 2,610 mm
Transport weight	4 t (4,7 t*)	6,3 t	7 t
Options	second screen deck with additional conveyor belt for oversized material (throughput up to 100 t/h, total weight 4.7 t)	-	-



JOB STORY

CRUSHER AND SCREEN BLESSED BEFORE STARTING OPERATION IN MANILA

Philippine mining company starts processing limestone with RM

This RM customer is well-known primarily for nickel mining. Now they have expanded their business model with RM to include mobile processing of limestone for cement production. Following training and start-up by the RM service technician and the traditional blessing ritual, the 12 tonne RM 60 plus RM CS2500 screen has been in operation up to eight hours a day.

WORKING DIMENSIONS

RM CS2500

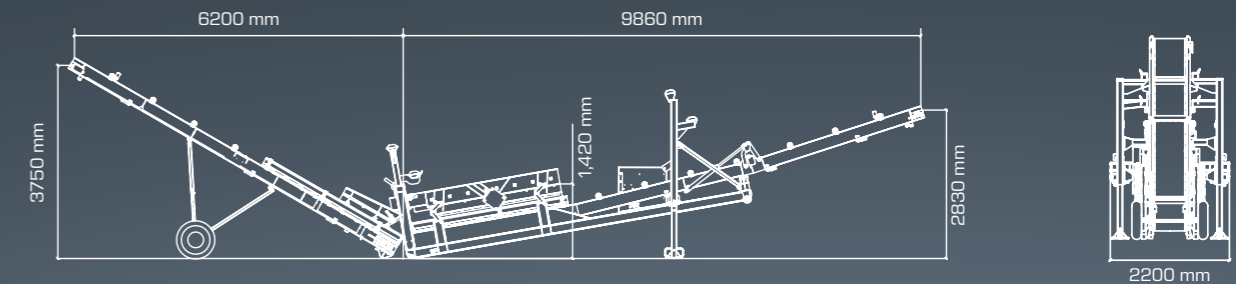

RM CS3600

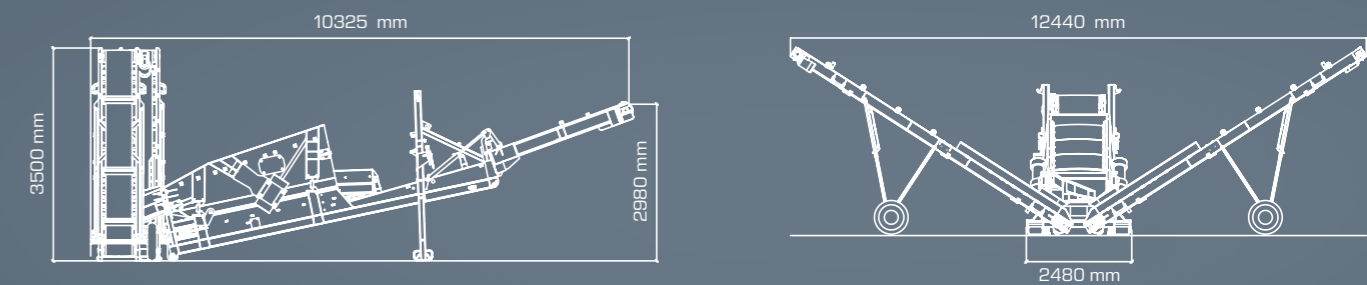

RM CS4800

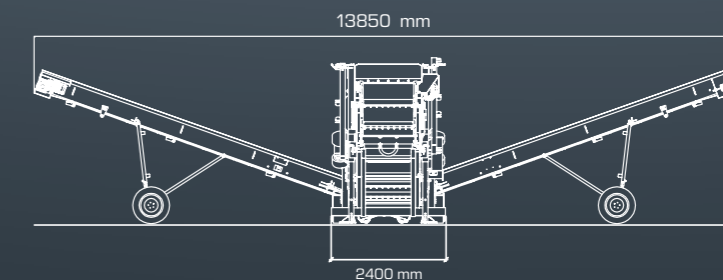
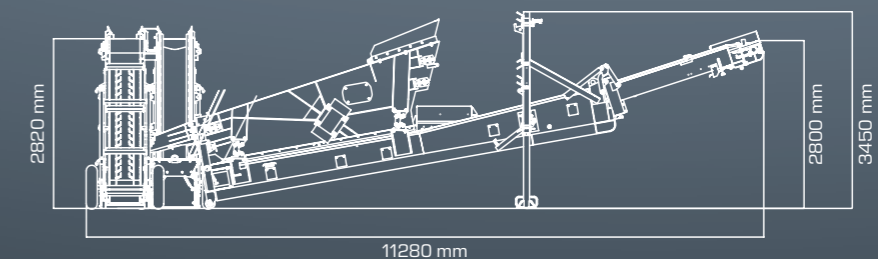

Dimensions in mm. Specifications subject to change in line with technical developments. The machine complies with Guideline 2006/42/EC of the European Parliament.

HIGHLIGHTS RM MTS SERIES

STACKERS – Tracked stockpiling conveyors

The tracked mobile stackers are easy to set up conveyors with low operational costs. Using these conveyors reduces on-site material handling which means increasing profit margins.



JOB STORY

TERRALUK TIEFBAU GMBH FLAGSHIP PROJECT

The figures are impressive: 90 % of the processed material is used again

The strict regulations imposed by the city of Basel in terms of environmental protection were easily undercut by Terraluk with the assistance of the RM 120GO!. This was supported by an RM HS5000M coarse material screening plant and an RM MTS2010 stockpile belt with crawler gear. 60,000 m³ of material will be processed here over the next two years.

RM MTS SERIES

STACKER SERIES
TRACKED STOCK PILING CONVEYORS

	RM MTS2010S	RM MTS2412S
Engine	CAT C2.2 Tier 3a Deutz 2.9 L4 Stage 3b / T4F	Deutz TD2011 3a Deutz 2.9 L4 Stage 3b / T4F
Engine power	42 kW	49 kW
Diesel tank capacity	185 l	195 l
Feed hopper, volume	1.3 m ³	1.4 m ³
Transport dimensions (L x W x H)	11,960 x 2,245 x 2,560 mm	11,900 x 2,585 x 2,640 mm
Conveyor belt width		
width	1,000 mm	1,200 mm
length	20 m	24 m
discharge height	max. 9,295 mm	max. 10,050 mm
Weight	13,000 kg	15,020 kg

WORKING DIMENSIONS

RM MTS2010S

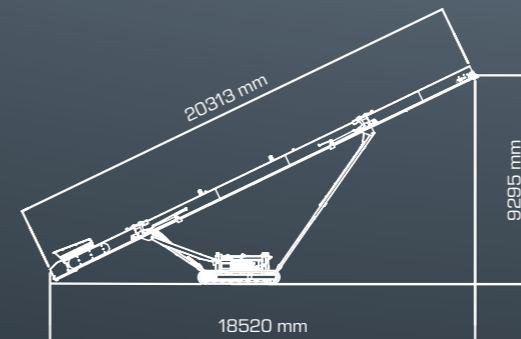

RM MTS2412S

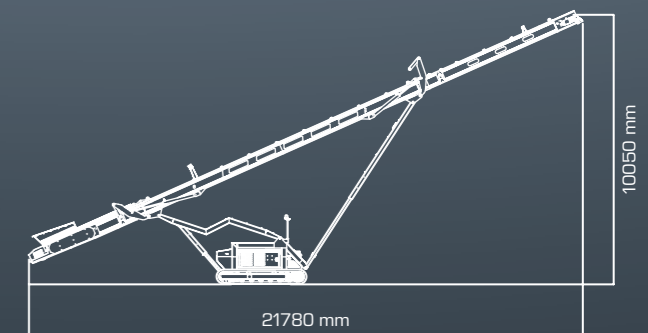

Dimensions in mm. Specifications subject to change in line with technical developments. The machine complies with Guideline 2006/42/EC of the European Parliament.

RM MAKES THE DIFFERENCE



QUARRY



Natural stone mixture



HS and MSC series



Screened natural stone fractions

SOIL / TOPSOIL



Soil/topsoil mixture



HS series



Screened soil/topsoil fractions

ASPHALT



Waste asphalt



HS and MSC series



Screened asphalt fractions

WOODCHIPS



Woodchip mixtures



HS series



Screened woodchip fractions

C&D WASTE MATERIAL



C&D waste material



HS and MSC series



Screened C&D waste fractions

Welcome! to our world



RUBBLEMASTER.COM

RUBBLE MASTER HMH GmbH
Im Südpark 196, AT 4030 Linz, AUSTRIA
Tel: +43 732 - 73 71 17 - 0
Fax: +43 732 - 73 71 17 - 101
E-Mail: sales@rubblemaster.com
WEB: RUBBLEMASTER.COM

