

# E-series

Articulated Dump Trucks

B25E | B30E | Mk 3

Stage V Certified



**BELL**

# E is for evolution

Your business is our business. Bell Articulated Dump Trucks haul more, for longer at the lowest cost-per-tonne to deliver more on your profit margins.

As a global leader in Articulated Dump Trucks, Bell Equipment brings you the world class E-series range. The evolutionary E-series is packed with class leading features that deliver production boosting payloads, lower daily operating costs, superior ride quality and uncompromised safety standards.

Bell E-series ADTs will give your business the competitive edge you need.

- Extensive use of high-strength, lightweight materials give these trucks the best payload-to-mass ratios and hauling efficiencies in each class.

- With their oscillating frame and high-floatation tyres, Bell trucks won't leave you stuck on muddy, rutted or hilly terrain.

- The redesigned sound-suppressed cab features fatigue-beating controls, advanced diagnostic monitor and a sealed-switch module for convenient, fingertip operation of numerous functions.

- Fuel-efficient emission-certified engines deliver clean power without compromise in all conditions. Leading edge emissions technology ensures rapid engine response and dependable cold-start performance.



The new E-series range takes ADT functionality to new industry standards, with customer-focused enhancements and the highest level of automated machine protection available.

Through substantial investments in Research and Development and employing industry leading technology, advancements have been made in the key areas of performance and fuel efficiency – helping you to move more material at lower operating costs and environmental impact.

Specifications	B25E	B30E
<b>Gross power</b>	210 kW (281 hp)	260 kW (348 hp)
<b>Operating mass</b>		
Empty	19 660 kg (43 343 lb)	20 310 kg (44 776 lb)
Loaded	43 660 kg (96 253 lb)	48 310 kg (106 505 lb)
<b>Rated payload</b>	24 000 kg (52 911 lb)	28 000 kg (61 729 lb)
<b>2:1 heaped capacity</b>	15 m <sup>3</sup> (19,5 yd <sup>3</sup> )	17,5 m <sup>3</sup> (22,9 yd <sup>3</sup> )



# Building on pedigree

Building on from the D-series platform, Bell Equipment's evolutionary approach to design delivers optimised power-to-weight ratio and legendary fuel efficiency.

- Limited-slip differentials and electronically controlled automatic Inter-axle Differential Lock (IDL) provide Automatic Traction Control (ATC) in poor underfoot conditions.
- The best-in-class payload-to-empty weight ratio means that more of your fuel cost is spent moving the material, not running the machine, decreasing your cost per tonne.
- An industry leading, fully automatic six-speed planetary transmission with torque converter lock-up maximises fuel efficiency.
- Automatic retardation slows the truck when the operator backs off the accelerator pedal for more confidence on steep grades and enhanced brake life.
- Improved payloads, faster haul cycles and industry leading fuel economy all help you move more material at a lower-cost-per-tonne than your competitors.

- High-travel suspension keeps all tyres in constant contact with the ground, for optimum traction.
- Electronic common rail fuel system provides high injection pressures even at low engine speed for improved cold-starting ability, low-speed response and reduced emissions.
- The short front end provides the best approach angle that allows these ADTs to attack steep terrain.
- With a high oscillating frame joint, articulated steering, and high-floatation tyres, these hard working haulers won't let wet weather or steep grades dampen your plans.

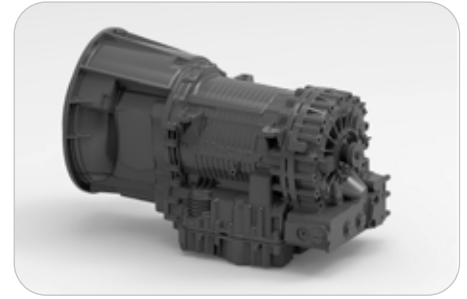

Planetary powershift transmission optimises shift points to match conditions and vehicle weight while protecting the transmission from operator error and abuse. Allison FuelSense® calibration optimises production and fuel burn.



The transfer case inter-axle differential delivers equal torque to each axle when traction is favourable. When conditions deteriorate, the diff-lock automatically engages to deliver torque to the tyres that can best use it.



High-strength steel and widely spaced taper roller bearings in the articulation area enhance long-term durability.



A tailgate is available as an option for better material retention. The tailgate opens as the bin is raised for dumping. Spring steel straps maintain positive seal throughout the haul, ensuring minimal material is lost.

Our innovative front and rear comfort ride suspension options are offered to even further enhance ride quality and ensure minimal whole body vibration exposure.

Productivity increases through reduced cycle times, and reduced haul road maintenance are even further benefits of these extremely successful systems. Experienced ADT operators who have driven trucks installed with these systems have come away amazed by the comfort of the machine, as well as the confidence that the adaptive front suspension engenders.



# Uncompromised durability

Built smarter, to work harder. Bell ADTs offer optimised machine weights so you spend more time and money moving material and not running the machine.

With decades of ADT experience, the new Bell E-series articulated hauler is designed and manufactured using purpose built, reliable Bell components best suited for the toughest of conditions. The central oscillation joint, high suspension travel on all axles, and balanced weight distribution provide the agility and ability to navigate hostile terrain.



The high-strength steel chassis delivers strength and rigidity without excess weight.



For comfortable productivity, the A-frame suspension system coupled with hydropneumatic suspension struts reduce the lateral vibration often experienced with off-road conditions. A superior suspension seat provides additional isolation for the operator.



Rough terrain demands tough suspensions. Heavy-duty components absorb shocks and come back for more. You get best-in-class suspension travel and ground clearance, too.

- Dual circuit hydraulically actuated dry-disc brakes on the B25E deliver consistent “on-the-mark” braking, even in cold weather. Simplified design makes them easy to maintain.

- Fully enclosed, dual circuit wet disc brakes on the B30E offer superior braking performance and extended service life essential for wet and muddy conditions. Oil-immersed wet-disc brakes are virtually maintenance-free.

- Viscous electronically controlled direct-drive engine fans provide cooling for the best efficiency.

- Class leading engine braking coupled with automated transmission retardation, provides superior braking power and reduces service brake wear.



Other uptime-boosting features include world class on-board diagnostics with live stream functionality, solid-state sealed switches and satellite fleet management system.

High-strength welded-alloy steel chassis and reinforced articulation joints, offer superior strength and durability with optimized weight for class leading power-to-weight ratio. Lower machine mass reduces powertrain and structural stress.

# Run leaner and cleaner

A combination of an optimally tuned engine and weight optimised complete machine package ensure that Bell ADTs have a minimal carbon footprint.

SCR uses AdBlue®/DEF which

- is non-toxic, odourless, low cost and simple to refill.
- is injected into the flow of the exhaust gases and reacts with the NOx gases in the catalytic convertor to form harmless nitrogen and water.
- is consumed at approximately 3-5% of your fuel usage.

EGR

- recirculates burnt exhaust gas back into the combustion chamber, lowering combustion temperatures and NOx production.

DPF

- Our DPF technology has been used in Mercedes-Benz road trucks for over 10 years.
- Regeneration is done during normal operation as much as possible.
- In light applications stationary active regeneration may be necessary.



- Reduced emissions
- Improved engine efficiency
- Lower fuel consumption
- Improved power
- Improved torque
- Improved engine response







- Stage V emissions control coupled with the lowest fuel burn ensures the lowest environmental impact.

Our E-series truck platform easily accommodates the new engine and related emissions control technology and reflects our strategy of continuous improvement.

**B**ell Equipment's evolutionary E-series runs SCR-technology (Selective Catalytic Reduction) in combination with EGR and a diesel particulate filter (DP) to give an industry leading standard in fuel-efficient emission control, designed specifically for the off-highway market to be compliant to Stage V. Engine power and fuel consumption have been further optimised through event dependant software that controls retardation, cooling and charging of accumulators.

# Operate with ease

Using the latest in automotive technology and state-of-the-art tooling, the E-series takes operator experience to new heights.

Climb into the cab of a Bell ADT and you will feel right at home. Its quiet, spacious interior, ergonomically positioned operator station and climate-controlled cabin is loaded with productivity boosting comfort and convenience features that minimise operator fatigue and enhance the operator's experience.

Modern flowing lines, in keeping with current styling trends on road vehicles, offer unsurpassed levels of visibility.

From the state-of-the-art 10" full colour screen, automotive mouse interface and sealed switch module with centrally located sealed display unit to air suspension seat, tilt/telescoping steering wheel and optional CD player with high-output speakers, the E-series provides everything your operators need to perform at their best.

- The standard sound-suppression package significantly reduces noise levels and operator fatigue.

- The adaptive transmission control adjusts clutch engagement to ensure smooth, consistent shifts throughout the life of the truck.

- A fully adjustable air-suspension seat with variable damping, auto height adjust according to operator weight, pneumatic lumbar support and multipoint harness for class-leading comfort and safety.

- A purpose designed HVAC climate control system with automotive-style louvres keeps the glass clear and the cab comfortable.

- New machine styling and cabin design improvements, which include full glass access door and high visibility mirror package, provide exceptional all-round visibility.

- You won't find retarder pedals or levers in a Bell truck. Retarder aggressiveness is simply set on the switch pad. Everything else is automatic.



Easy-to-understand instruments and intuitive controls wrap around the operator so they're easier to view and operate.



A user friendly 10" colour monitor offers vital operating information, safety warnings, detailed diagnostic readings and dump body function settings.



An automotive controller provides menu navigation on the colour monitor to extract information on machine operation and adjustment of machine settings.



Convenient sealed switch module provides fingertip control of numerous productivity enhancing functions including: **Keyless Start, I-Tip, Dump Body Upper Limit, Soft Stop/Hard Stop Selection, Retarder Aggressiveness and Speed Control.**



# Safety, our business too

By listening to users and delivering on expectations in an ever changing workplace, we provide a truck that leads in application safety with numerous groundbreaking innovations.

Independent features such as Keyless Start, Hill Assist, Bin Tip Prevention, Auto Park Application (APA), Standard Turbo Spin Protection and On-Board Weighing (OBW) are still standard on the E-series.

For improved safety and productivity, the E-series has an electronically controlled automatic Inter-axle Differential Lock (IDL) giving the vehicle full Automatic Traction Control (ATC).

- Full handrails (to ISO 2876) can be installed to offer improved safety when performing engine checks.
- The park brake automatically applies when neutral is selected and it is not possible to engage neutral at speed. Torque dependent park brake release (Hill Assist) ensures no roll back on slopes.
- All trucks can be set up to automatically sound the horn when starting or switching between forward and reverse.

- Best-in-class retarder and engine braking automatically applies when the operator lifts his foot off the accelerator. Retarder aggressiveness can be simply adjusted on the sealed switch module ensuring maximum descent control for all conditions.
- Multiple geofencing in challenging site conditions ensures safe machine operation, such as downhill speed control, geofence speed limits and bin restrictions.



Our quiet operator cabins are ROPS/FOPS certified with an air suspension operator seat. The trainer seat has a retractable lap belt while the operator seat has a standard 3 point seat belt. Both have automatically locking retractors.



An optional integrated reverse camera and high visibility mirrors ensure superior all round visibility.



Keyless start, driver identity and access codes ensure no unauthorised operation of your equipment.



The exclusive on-board weighing presents the operator with real time information on the payload while the machine is being loaded. A 'speed restriction' mode can also be activated if the machine is significantly overloaded.



The incorporation of a pitch and roll sensor in the vehicle prevents bin operation if the truck is in an unsafe position.



Both operator or site selectable maximum speed control allows the vehicle to automatically decelerate and apply the retarder to prevent onsite speeding.



# Maximise your uptime

The E-series is loaded with features that make it as easy to maintain as it is to operate. Spend less time and expense getting ready for work and more time getting work done.

Easy-to-reach dipsticks, see-through reservoirs, sight gauges and grouped service points make quick work of the daily routine. Quickchange filters, extended engine and hydraulic oil-service intervals lower daily operating costs and provide superior machine uptime.

An industry leading 10" colour monitor offers on-board machine diagnostics as well as automated daily service functionality, this coupled with diagnostic test ports help you troubleshoot and make informed maintenance decisions on site.



If something goes wrong, the diagnostic monitor provides service codes and supporting info to help diagnose the problem.



The cab can be tilted in minutes without special tools, for convenient service access to drivetrain components.



An in-cab load center simplifies fuse replacement. Fewer relays, connectors and harnesses mean higher reliability.



We offer a remote transmission filter option. They make transmission filter replacement a fast and clean task.



- Automated daily service checks can be done with ease and comfort from inside the operator station using the 10" colour LCD monitor and sealed display controller.

- The load-sensing hydraulic system was designed with simplicity in mind, while maintaining efficiency. Fewer components for improved reliability and serviceability.

- Extended engine transmission and hydraulic oil-change for increased uptime and lower operating cost.

- Available environmental drains allow quick, no-spill changes.

- Your Bell Service Centre has the parts and backup you need to stay productive and offers a wide variety of preventative maintenance and support programmes to help you control costs.



See-through fluid reservoirs and sight gauges let you check fluid levels at a glance.



Easily accessible test ports allow technicians to troubleshoot problems more quickly.



The centralised lube bank places difficult-to-reach grease points within reach.



The convenient and easy to understand RSG decal details daily checks and actions (eg: greasing).

Welcome to the ...

**BELL** Family

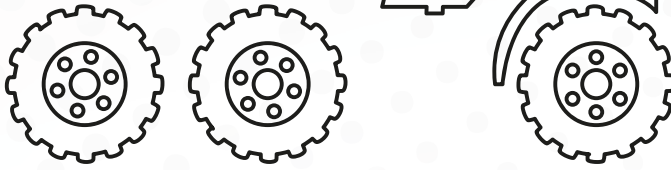

“Power up and plug in to our end-to-end customer solutions!”

**START**

Through our living motto **‘Strong Reliable Machines, Strong Reliable Support’**, we offer both exceptional equipment and aftermarket support products because we want your Bell ownership experience to be a happy one.



**SETTING YOU UP FOR SUCCESS**



**TRAINING**

**PROTECTING YOUR ASSETS**



**LUBE CHECK**



**MAINTENANCE CONTRACT**



**EXTENDED WARRANTY**



**FLEETM@TIC®**



**KEEPING YOUR MACHINE RUNNING**

**LUBRICANTS**

**PARTS**

**SERVICE KITS**

**TECHNICAL SUPPORT**

**SPECIAL TOOLS**

**BELL OUTLETS**

**GIVING YOU EXTRA VALUE, LONGER LIFE**



**REMAN COMPONENTS**



**PRE-OWNED EQUIPMENT**

**SUPPORTING YOU EVERY STEP OF YOUR BELL OWNERSHIP EXPERIENCE**



# Smarter fleet management



Cutting edge technology, helping you run your fleet smarter. Providing accurate, up-to-date operational data, production data and diagnostic data.

The key to a productive and profitable fleet, lies in the ability to monitor and manage your machines and operators efficiently. Machine operational data is processed and compiled into useful production and performance statistics, accessible via the Bell Fleetm@tic® website. These reports are also automated and emailed directly to you. The two monitoring packages that we have available, are:

- **The Classic Package** supplies you with good enough information for you to have a very good understanding of how your machines is operating for each shift that it runs. This package comes standard with the machine for 2 years.
- **The Premium Package** is focused on customers who need to have extremely detailed information of the machine's operation. For this package we offer similar information to that of the Classic Package but for each individual laden - unladen cycle. In addition, live tracking is available on the Fleetm@tic® website on a per minute basis.

## Fleetm@tic®:

- Maximise productivity
- Generate machine utilisation reports
- Identify operator training requirements
- Pro-active maintenance planning
- Implement safety features
- Receive machine fault codes as well as suggested trouble shooting procedures
- Protect investments
- Receive real time geospatial data



# B25E Articulated Dump Truck

<p><b>ENGINE</b></p> <p><b>Manufacturer</b> Mercedes Benz</p> <p><b>Model</b> OM936LA</p> <p><b>Configuration</b> Inline 6, turbocharged and intercooled</p> <p><b>Gross Power</b> 210 kW (281 hp) @ 2 200 rpm</p> <p><b>Net Power</b> 201 kW (269 hp) @ 2 200 rpm</p> <p><b>Gross Torque</b> 1 150 Nm (848 lbf) @ 1 200-1 600 rpm</p> <p><b>Displacement</b> 7,7 litres (469 cu.in)</p> <p><b>Auxiliary Brake</b> Engine Valve Brake</p> <p><b>Fuel Tank Capacity</b> 302 litres (79.78 US gal)</p> <p><b>AdBlue® Tank Capacity</b> 31 l (8.2 US gal)</p> <p><b>Certification</b> OM936LA meets EU Stage V emissions regulations</p>	<p><b>Torque Control</b> Hydrodynamic with lock-up in all gears</p> <p><b>TRANSFER CASE</b></p> <p><b>Manufacturer</b> Kessler</p> <p><b>Series</b> W1400</p> <p><b>Layout</b> Remote mounted</p> <p><b>Gear Layout</b> Three in-line helical gears</p> <p><b>Output Differential</b> Interaxle 33/67 proportional differential. Automatic inter-axle differential lock.</p> <p><b>AXLES</b></p> <p><b>Manufacturer</b> Bell</p> <p><b>Model</b> 15T</p> <p><b>Differential</b> High input limited slip differential with spiral bevel gears</p> <p><b>Final Drive</b> Outboard heavy duty planetary on all axles</p> <p><b>BRAKING SYSTEM</b></p> <p><b>Service Brake</b> Dual circuit, full hydraulic actuation dry disc brakes with 8 calipers (4F, 2M, 2R).</p> <p>Maximum brake force: 184 kN (41 400 lbf)</p> <p><b>Park &amp; Emergency</b> Spring applied, air released driveline mounted disc</p> <p>Maximum brake force: 195 kN (43 900 lbf)</p> <p><b>Auxiliary Brake</b> Automatic engine valve brake. Automatic, adjustable, integral, hydrodynamic transmission retarder. Output shaft speed dependant.</p> <p><b>Total Retardation Power</b> Continuous: 318 kW (426 hp) Maximum: 588 kW (788 hp)</p>	<p><b>WHEELS</b></p> <p><b>Type</b> Radial Earthmover</p> <p><b>Tyre</b> 23.5 R 25</p> <p><b>FRONT SUSPENSION</b> Semi-independent, leading A-frame supported by hydro-pneumatic suspension struts.</p> <p><b>REAR SUSPENSION</b> Pivoting walking beams with laminated rubber suspension blocks.</p> <p><b>HYDRAULIC SYSTEM</b> Full load sensing system serving the prioritized steering, body tipping and brake functions. A ground-driven, load sensing emergency steering pump is integrated into the main system.</p> <p><b>Pump Type</b> Variable displacement load sensing piston</p> <p><b>Flow</b> 165 l/min (44 gal/min)</p> <p><b>Pressure</b> 28 MPa (4 061 psi)</p> <p><b>Filter</b> 5 microns</p> <p><b>STEERING SYSTEM</b> Double acting cylinders, with ground-driven emergency steering pump.</p> <p><b>Lock to lock turns</b> 4,1</p> <p><b>Steering Angle</b> 45°</p> <p><b>DUMPING SYSTEM</b> Two double-acting, single stage, dump cylinders</p> <p><b>Raise Time</b> 14,5 s</p> <p><b>Lowering Time</b> 7,5 s</p>	<p><b>Tipping Angle</b> 70° standard, or any lower angle programmable</p> <p><b>PNEUMATIC SYSTEM</b> Air drier with heater and integral unloader valve, serving park brake and auxiliary functions.</p> <p><b>System Pressure</b> 810 kPa (117 psi)</p> <p><b>ELECTRICAL SYSTEM</b></p> <p><b>Voltage</b> 24 V</p> <p><b>Battery Type</b> Two AGM (Absorption Glass Mat) type</p> <p><b>Battery Capacity</b> 2 X 75 Ah</p> <p><b>Alternator Rating</b> 28V 80A</p> <p><b>VEHICLE SPEEDS</b></p> <table border="1"> <tr><td>1st</td><td>7 km/h</td><td>4 mph</td></tr> <tr><td>2nd</td><td>15 km/h</td><td>9 mph</td></tr> <tr><td>3rd</td><td>23 km/h</td><td>14 mph</td></tr> <tr><td>4th</td><td>35 km/h</td><td>22 mph</td></tr> <tr><td>5th</td><td>47 km/h</td><td>29 mph</td></tr> <tr><td>6th</td><td>50 km/h</td><td>31 mph</td></tr> <tr><td>R</td><td>7 km/h</td><td>4 mph</td></tr> </table> <p><b>CAB</b> ROPS/FOPS certified 72 dBA internal sound level measured according to ISO 6396.</p>	1st	7 km/h	4 mph	2nd	15 km/h	9 mph	3rd	23 km/h	14 mph	4th	35 km/h	22 mph	5th	47 km/h	29 mph	6th	50 km/h	31 mph	R	7 km/h	4 mph
1st	7 km/h	4 mph																						
2nd	15 km/h	9 mph																						
3rd	23 km/h	14 mph																						
4th	35 km/h	22 mph																						
5th	47 km/h	29 mph																						
6th	50 km/h	31 mph																						
R	7 km/h	4 mph																						

## Load Capacity & Ground Pressure

OPERATING WEIGHTS		GROUND PRESSURE				LOAD CAPACITY		OPTION WEIGHTS	
UNLADEN	kg (lb)	LADEN (No sinkage)				BODY	m <sup>3</sup> (yd <sup>3</sup> )		
		23.5 R 25	kPa (Psi)	23.5 R 25	kPa (Psi)			kg (lb)	
Front	10 085 (22 230)	23.5 R 25	kPa (Psi)	23.5 R 25	kPa (Psi)	Struck Capacity	12 (15,7)	Bin liner	1 050 (2 314)
Middle	4 805 (10 600)	Front	246 (36)	Front	230 (33)	SAE 2:1 Capacity	15 (19,5)	Tailgate	769 (1 695)
Rear	4 770 (10 520)	Middle	337 (49)	Middle	283 (41)	SAE 1:1 Capacity	18 (23,5)	Extra wheelset	565 (1 246)
Total	19 660 (43 350)	Rear	337 (49)	Rear	283 (41)	SAE 2:1 Capacity with Tailgate	15,5 (20,3)		
<b>LADEN</b>									
Front	12 825 (28 274)								
Middle	15 435 (34 028)					Rated Payload	24 000 kg		
Rear	15 400 (33 951)						(52 911 lbs)		
Total	43 660 (96 253)								

# Dimensions

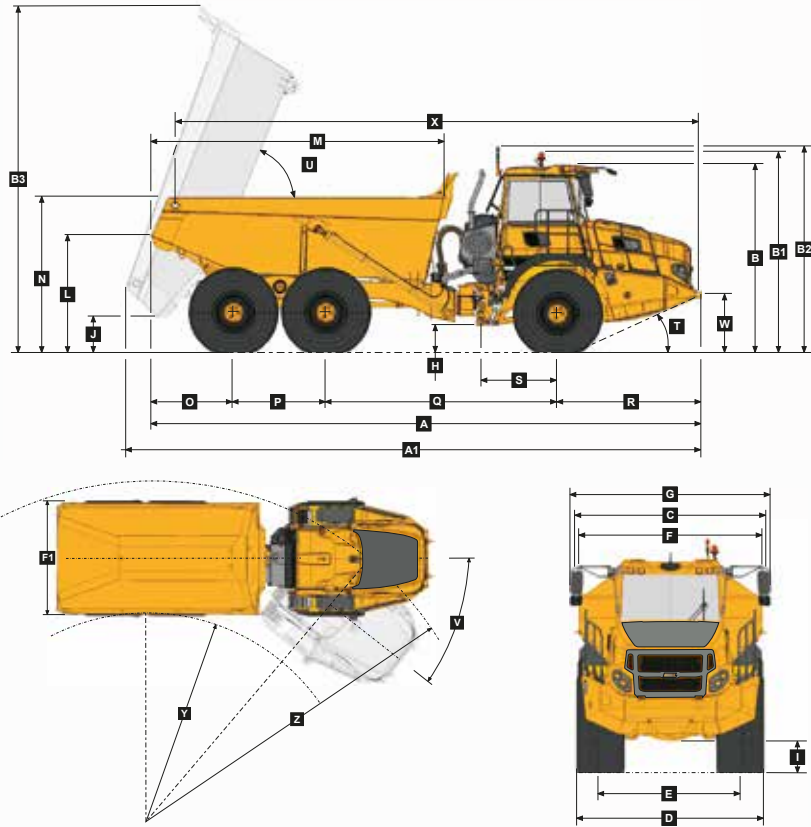

## Machine Dimensions

A	Length - Transport Position	9953 mm (32 ft. 7 in.)
A1	Length - Bin Fully Tipped	10311 mm (33 ft. 9 in.)
B	Height - Transport Position	3426 mm (11 ft. 2 in.)
B1	Height - Rotating Beacon	3661 mm (12 ft.)
B2	Height - Load Light	3747 mm (12 ft. 3 in.)
B3	Bin Height - Fully Tipped	6255 mm (20 ft. 6 in.)
C	Width over Mudguards	2985 mm (9 ft. 9 in.)
D	Width over Tyres - 23.5R25	2940 mm (9 ft. 7 in.)
E	Tyre Track Width - 23.5R25	2356 mm (7 ft. 8 in.)
F	Width over Bin	2700 mm (8 ft. 10 in.)
F1	Width over Tailgate	2998 mm (9 ft. 10 in.)
G	Width over Mirrors - Operating Position	3260 mm (10 ft. 8 in.)
H	Ground Clearance - Artic	537 mm (21.14 in.)
I	Ground Clearance - Front Axle	488 mm (19.21 in.)
J	Ground Clearance - Bin Fully Tipped	670 mm (26.38 in.)
K	Ground Clearance - Under Run Bar	N/A
L	Bin Lip Height - Transport Position	2176 mm (7 ft. 1 in.)
M	Bin Length	5272 mm (17 ft. 3 in.)
N	Load over Height	2763 mm (9 ft.)
O	Rear Axle Centre to Bin Rear	1500 mm (4 ft. 11 in.)
P	Mid Axle Centre to Rear Axle Centre	1670 mm (5 ft. 5 in.)
Q	Mid Axle Centre to Front Axle Centre	4181 mm (13 ft. 8 in.)
R	Front Axle Centre to Machine Front	2602 mm (8 ft. 6 in.)
S	Front Axle Centre to Artic Centre	1362 mm (4 ft. 5 in.)
T	Approach Angle	25 °
U	Maximum Bin Tip Angle	70 °
V	Maximum Articulation Angle	45 °
W	Front Tie Down Height	1075 mm (3 ft. 6 in.)
X	Machine Lifting Centres	9477 mm (31 ft. 1 in.)
Y	Inner Turning Circle Radius - 23.5R25	4110 mm (13 ft. 5 in.)
Z	Outer Turning Circle Radius - 23.5R25	8000 mm (26 ft. 2 in.)

# Grade Ability/Rimpull

1. Determine tractive resistance by finding intersection of vehicle mass line and grade line. NOTE: 2% typical rolling resistance is already assumed in chart and grade line.
2. From this intersection, move straight right across charts until line intersects rimpull curve.
3. Read down from this point to determine maximum speed attained at that tractive resistance.

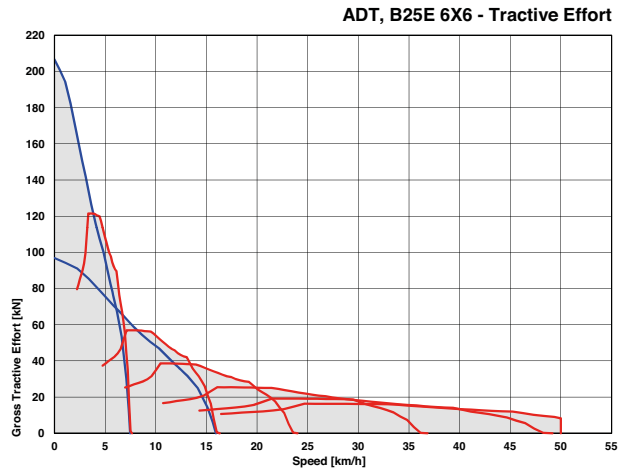
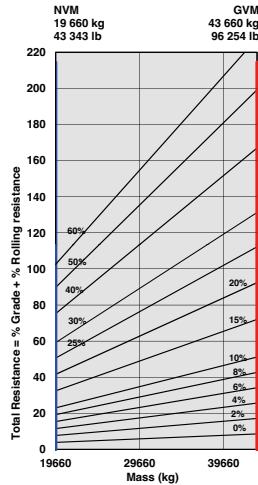

# Retardation

1. Determine retardation force required by finding intersection of vehicle mass line.
2. From this intersection, move straight right across charts until line intersects the curve. NOTE: 2% typical rolling resistance is already assumed in chart.
3. Read down from this point to determine maximum speed.

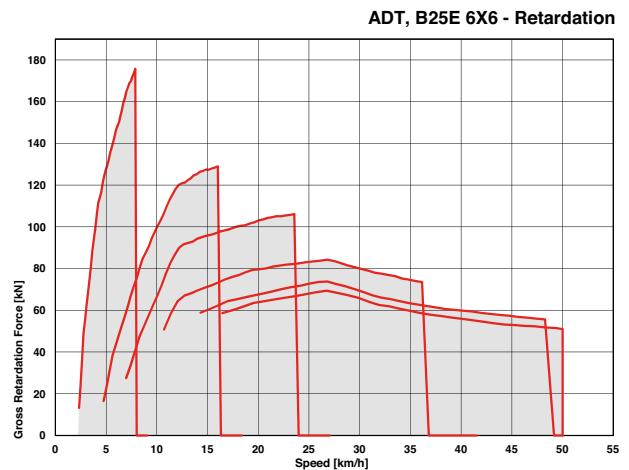
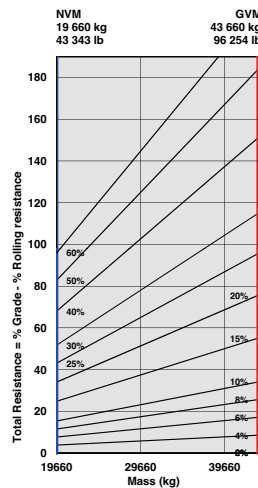

# B30E Articulated Dump Truck

## ENGINE

**Manufacturer**  
Mercedes Benz

**Model**  
OM936LA

**Configuration**  
Inline 6, turbocharged and intercooled

**Gross Power**  
260 kW (348 hp) @ 2 200 rpm

**Net Power**  
250 kW (335 hp) @ 2 200 rpm

**Gross Torque**  
1 450 Nm (1 069 lbf ft)  
@ 1 150 - 1 800 rpm

**Displacement**  
7,7 litres (469 cu.in)

**Auxiliary Brake**  
Engine Valve Brake

**Fuel Tank Capacity**  
302 litres (79.78 US gal)

**AdBlue® Tank Capacity**  
31 l (8.2 US gal)

**Certification**  
OM936LA meets EU Stage V emissions regulations

## TRANSMISSION

**Manufacturer**  
Allison

**Model**  
3400 ORS

**Configuration**  
Fully automatic planetary transmission

**Layout**  
Engine mounted

**Gear Layout**  
Constant meshing planetary gears, clutch operated

**Gears**  
6 Forward, 1 Reverse

**Clutch Type**  
Hydraulically operated multi-disc

**Control Type**  
Electronic

**Torque Control**  
Hydrodynamic with lock-up in all gears

## TRANSFER CASE

**Manufacturer**  
Kessler

**Series**  
W1400

**Layout**  
Remote mounted

**Gear Layout**  
Three in-line helical gears

**Output Differential**  
Interaxle 33/67 proportional differential. Automatic inter-axle differential lock.

## AXLES

**Manufacturer**  
Bell

**Model**  
18T

**Differential**  
High input limited slip differential with spiral bevel gears

**Final Drive**  
Outboard heavy duty planetary on all axles.

## BRAKING SYSTEM

**Service Brake**  
Dual circuit, full hydraulic actuation wet disc brakes on front and middle axles. Wet brake oil is circulated through a filtration and cooling system.

Maximum brake force:  
178 kN (40 000 lbf)

**Park & Emergency**  
Spring applied, air released driveline mounted disc

Maximum brake force:  
214 kN (48 200 lbf)

**Auxiliary Brake**  
Automatic engine valve brake. Automatic retardation through electronic activation of wet brake system.

**Total Retardation Power**  
335kW (449 hp) Continuous  
494kW (662 hp) Maximum

## WHEELS

**Type**  
Radial Earthmover

**Tyre**  
23.5 R 25 (750/65 R 25 optional)

## FRONT SUSPENSION

Semi-independent, leading A-frame supported by hydro-pneumatic suspension struts.

## REAR SUSPENSION

Pivoting walking beams with laminated rubber suspension blocks.

## HYDRAULIC SYSTEM

Full load sensing system serving the prioritized steering, body tipping and brake functions. A ground-driven, load sensing emergency steering pump is integrated into the main system.

**Pump Type**  
Variable displacement load sensing piston

**Flow**  
165 l/min (44 gal/min)

**Pressure**  
28 MPa (4 061 psi)

**Filter**  
5 microns

## STEERING SYSTEM

Double acting cylinders, with ground-driven emergency steering pump.

**Lock to lock turns**  
4,1

**Steering Angle**  
45°

## DUMPING SYSTEM

Two double-acting, single stage, dump cylinders

**Raise Time**  
14,5 s

**Lowering Time**  
7,5 s

**Tipping Angle**  
70° standard, or any lower angle programmable

## PNEUMATIC SYSTEM

Air drier with heater and integral unloader valve, serving park brake and auxiliary functions.

**System Pressure**  
810 kPa (117 psi)

## ELECTRICAL SYSTEM

**Voltage**  
24 V

**Battery Type**  
Two AGM (Absorption Glass Mat) type

**Battery Capacity**  
2 X 75 Ah

**Alternator Rating**  
28V 80A

## VEHICLE SPEEDS

	7 km/h	4 mph
1st	7 km/h	4 mph
2nd	15 km/h	9 mph
3rd	23 km/h	14 mph
4th	35 km/h	22 mph
5th	47 km/h	29 mph
6th	50 km/h	31 mph
R	7 km/h	4 mph

## CAB

ROPS/FOPS certified 72 dBA internal sound level measured according to ISO 6396.

## Load Capacity & Ground Pressure

OPERATING WEIGHTS		GROUND PRESSURE				LOAD CAPACITY		OPTION WEIGHTS	
UNLADEN	kg (lb)	LADEN-No sinkage		LADEN-15% sinkage		BODY	m <sup>3</sup> (yd <sup>3</sup> )		kg (lb)
Front	10 790 (23 788)	23.5 R 25	kPa (Psi)	23.5 R 25	kPa (Psi)	Struck Capacity	14 (18,3)	Bin liner	1 182 (2 606)
Middle	4 990 (11 001)	Front	282 (41)	Front	246 (36)	SAE 2:1 Capacity	17,5 (22,9)	Tailgate	825 (1 818)
Rear	4 530 (9 987)	Middle	380 (55)	Middle	317 (46)	SAE 1:1 Capacity	21 (27,5)	Extra wheelset	
Total	20 310 (44 779)	Rear	380 (55)	Rear	317 (46)	SAE 2:1 Capacity		(23.5 R 25)	565 (1 246)
<b>LADEN</b>						with Tailgate	18 (23,5)	Extra wheelset	
Front	13 500 (29 760)	750/65 R 25	kPa (Psi)	750/65 R 25	kPa (Psi)			(750/65 R 25)	738 (1 627)
Middle	17 405 (38 371)	Front	235 (34)	Front	213 (31)	Rated Payload	28 000 kg		
Rear	17 365 (38 283)	Middle	310 (45)	Middle	274 (40)		(61 729 lbs)		
Total	48 310 (106 505)	Rear	310 (45)	Rear	274 (40)				

# Dimensions

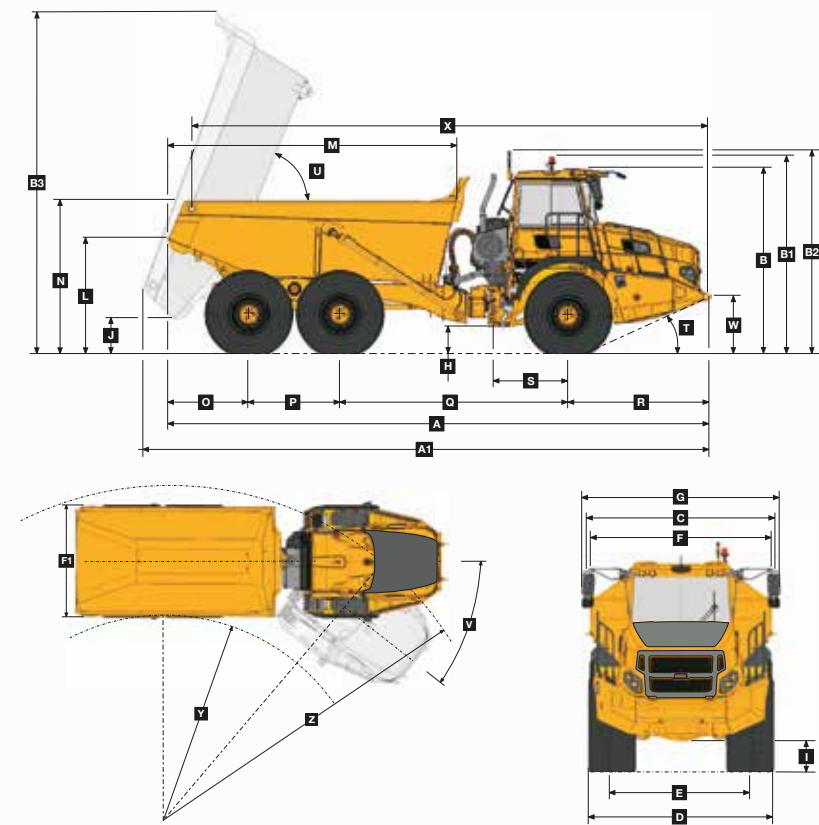

## Machine Dimensions

A	Length - Transport Position	9953 mm (32 ft. 7 in.)
A1	Length - Bin Fully Tipped	10395 mm (34 ft. 1 in.)
B	Height - Transport Position	3426 mm (11 ft. 2 in.)
B1	Height - Rotating Beacon	3661 mm (12 ft.)
B2	Height - Load Light	3747 mm (12 ft. 3 in.)
B3	Bin Height - Fully Tipped	6307 mm (20 ft. 8 in.)
C	Width over Mudguards	2985 mm (9 ft. 9 in.)
D	Width over Tyres - 23.5 R25	2940 mm (9 ft. 7 in.)
D1	Width over Tyres - 750/65 R25	2998 mm (9 ft. 10 in.)
E	Tyre Track Width - 23.5 R25	2356 mm (7 ft. 8 in.)
E1	Tyre Track Width - 750/65 R25	2260 mm (7 ft. 4 in.)
F	Width over Bin	2968 mm (9 ft. 8 in.)
F1	Width over Tailgate	3268 mm (10 ft. 8 in.)
G	Width over Mirrors - Operating Position	3260 mm (10 ft. 8 in.)
H	Ground Clearance - Artic	537 mm (21.14 in.)
I	Ground Clearance - Front Axle	488 mm (19.21 in.)
J	Ground Clearance - Bin Fully Tipped	670 mm (26.38 in.)
K	Ground Clearance - Under Run Bar	N/A
L	Bin Lip Height - Transport Position	2176 mm (7 ft. 1 in.)
M	Bin Length	5294 mm (17 ft. 4 in.)
N	Load over Height	2864 mm (9 ft. 4 in.)
O	Rear Axle Centre to Bin Rear	1500 mm (4 ft. 11 in.)
P	Mid Axle Centre to Rear Axle Centre	1670 mm (5 ft. 5 in.)
Q	Mid Axle Centre to Front Axle Centre	4181 mm (13 ft. 8 in.)
R	Front Axle Centre to Machine Front	2602 mm (8 ft. 6 in.)
S	Front Axle Centre to Artic Centre	1362 mm (4 ft. 5 in.)
T	Approach Angle	25 °
U	Maximum Bin Tip Angle	70 °
V	Maximum Articulation Angle	45 °
W	Front Tie Down Height	1075 mm (3 ft. 6 in.)
X	Machine Lifting Centres	9443 mm (30 ft. 11 in.)
Y	Inner Turning Circle Radius - 23.5 R25	4110 mm (13 ft. 5 in.)
Y1	Inner Turning Circle Radius - 750/65 R25	4081 mm (13 ft. 4 in.)
Z	Outer Turning Circle Radius - 23.5 R25	8000 mm (26 ft. 2 in.)
Z1	Outer Turning Circle Radius - 750/65 R25	8029 mm (26 ft. 4 in.)

# Grade Ability/Rimpull

1. Determine tractive resistance by finding intersection of vehicle mass line and grade line. NOTE: 2% typical rolling resistance is already assumed in chart and grade line.
2. From this intersection, move straight right across charts until line intersects rimpull curve.
3. Read down from this point to determine maximum speed attained at that tractive resistance.

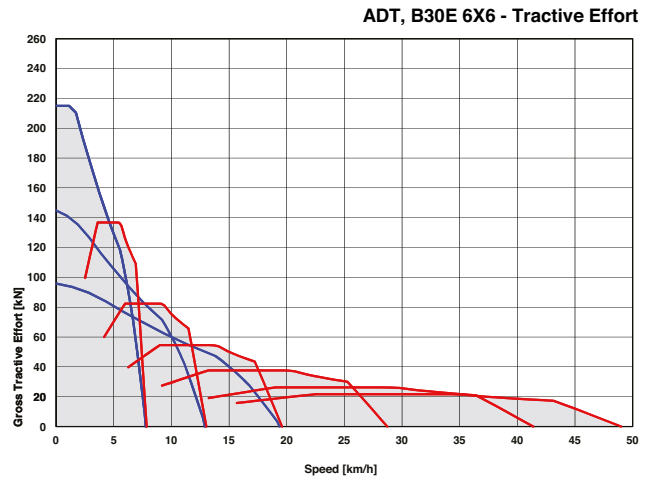
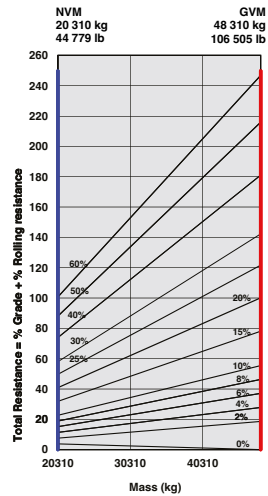

# Retardation

1. Determine retardation force required by finding intersection of vehicle mass line.
2. From this intersection, move straight right across charts until line intersects the curve. NOTE: 2% typical rolling resistance is already assumed in chart.
3. Read down from this point to determine maximum speed.

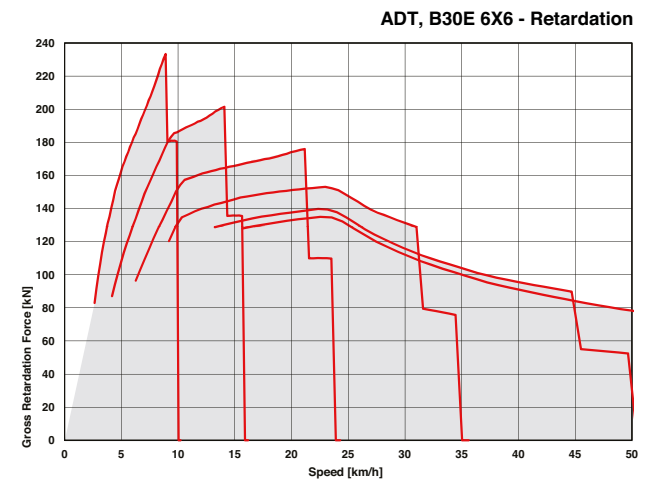
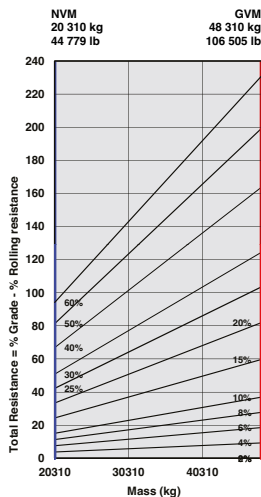

B25E	B30E	
<b>ENGINE</b>		
●	●	Engine valve brake
●	●	Dual element air cleaner with dust ejector valve
●	●	Precleaner with automatic dust scavenging
●	●	Water separator
●	●	Serpentine drive belt with automatic tensioner
●	●	Provision for fast fill
<b>COOLING</b>		
●	●	Crankshaft mounted electronically controlled viscous fan drive
●	●	Fan guard
<b>PNEUMATIC SYSTEM</b>		
●	●	Engine-mounted compressor
●	●	Air drier with heater
●	●	Integral unloader valve
<b>ELECTRICAL SYSTEM</b>		
●	●	Battery disconnect
●	●	Drive lights
●	●	Air Horn
●	●	Reverse alarm
▲	▲	White Noise reverse alarm
●	●	Rotating Beacon
●	●	Pitch Roll Sensor
●	●	LED reverse lights
▲	▲	LED Artic reverse light
▲	▲	Halogen Artic reverse light
<b>STEERING SYSTEM</b>		
●	●	Bi-directional ground-driven secondary steering pump
<b>CAB</b>		
●	●	ROPS/FOPS certification
●	●	Tilt cab
●	●	Gas strut-supported door
●	●	I-Tip programmable dump-body tip settings
●	●	HVAC Climate control system
●	●	AM/FM radio/CD player
●	●	Rear window guard
●	●	Wiper/washer with intermittent control
●	●	Tilt and telescoping steering wheel
●	●	Centre-mount air-suspension seat
▲	▲	LED work lights
●	●	Halogen work lights
▲	▲	Rotating beacon: seat belt installation
▲	▲	Remote engine and machine isolation
●	●	Remote battery jump start
●	●	Retractable 3 point seat belt
●	●	Heated seat
●	●	Foldaway trainer seat with retractable seat belt
●	●	12-volt power outlet
●	●	Cab utility bin (removable)

B25E	B30E	
<b>CAB (continued)</b>		
●	●	Cup holder
●	●	Cooled/heated lunch box
●	●	Electric adjustable and heated mirrors
●	●	Deluxe 10" colour LCD: Speedometer / Fuel gauge / Transmission oil temperature gauge / Engine coolant temperature gauge / LED function/warning indicators and audible alarm / Transmission gear selection / Tachometer / Battery voltage / Hour meter / Odometer / Fuel consumption / Tip counter / Trip timer / Trip distance / Metric/English units / Service codes/diagnostics
●	●	Backlit sealed switch module functions with: Wiper control / Lights / Heated mirrors / Retarding aggressiveness / Transfer case differential lock / Transmission gear hold / Dump-body tip limit / Automatic dump-body tip settings / Airconditioner/ Heater controls / Preselected Speed Control
<b>DUMP BODY</b>		
●	●	Dump body mechanical locks (x2). Partially up and fully up
▲	▲	Body liner
▲	▲	Tailgate
▲	▲	Body heater
▲	▲	Less dump body and cylinders
<b>OTHER</b>		
●	●	Automatic Traction Control (ATC)
●	●	Wet disc brakes B30E
●	●	Dry disc brakes B25E
●	●	23.5R25 Radial Earthmover tyres
▲	▲	750/65R25 Radial Earthmover tyres
●	●	Remote grease banks
▲	▲	Automatic greasing
●	●	Onboard Weighing
▲	▲	Load lights: stack
▲	▲	Comfort ride suspension (Front)
▲	▲	Comfort ride suspension (Rear)
▲	▲	Reverse camera
▲	▲	Hand rails
●	●	Cab peak
▲	▲	High pressure hydraulic filter
▲	▲	Fuel heater
●	●	Belly cover
●	●	Cross member cover
▲	▲	Remote transmission filters
●	●	Electronic Bonnet opening







All dimensions are shown in millimetres, unless otherwise stated between brackets. Under our policy of continuous improvement, we reserve the right to change technical data and design without prior notice. Photographs featured in this brochure may include optional equipment. Blu@vantage™ is a trademark of Bell Equipment Co. (PTY) Ltd AdBlue® is a registered trademark of VDA.

**BELL INTERNATIONAL: Tel: +27 (0)35-907 9431**

**E-mail: [marketing@bellequipment.com](mailto:marketing@bellequipment.com)**

**Web: [www.bellequipment.com](http://www.bellequipment.com)**

 Tel: +61 (0)8-9355-2442

 Tel: +49 (0)6631 / 91-13-0

 Tel: +27 (0)11-928-9700

 Tel: (704) 655 2802

 Tel: +33 (0)5-55-89-23-56

 Tel: +7-495-287-80-02

 Tel: +44 (0)1283-712862

**Strong Reliable Machines  
Strong Reliable Support**

**BELL**